

ES-4000 OX ELEVATIONS

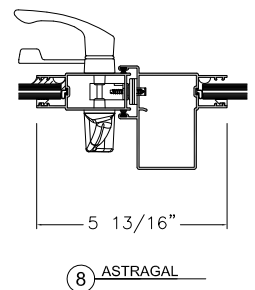

VERTICAL SECTIONS

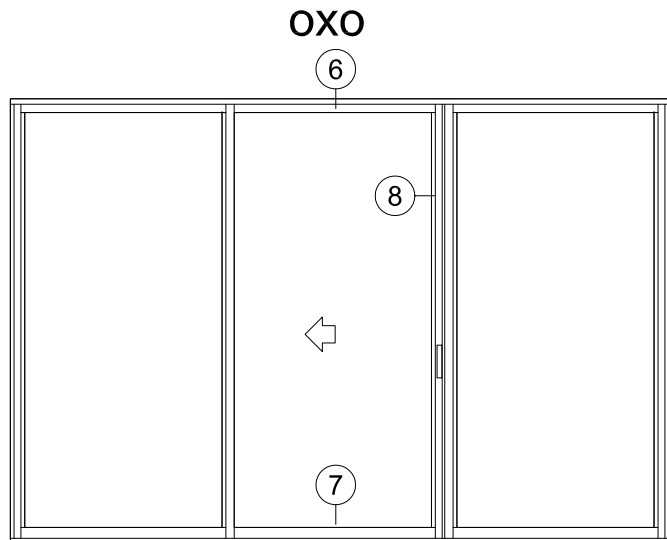
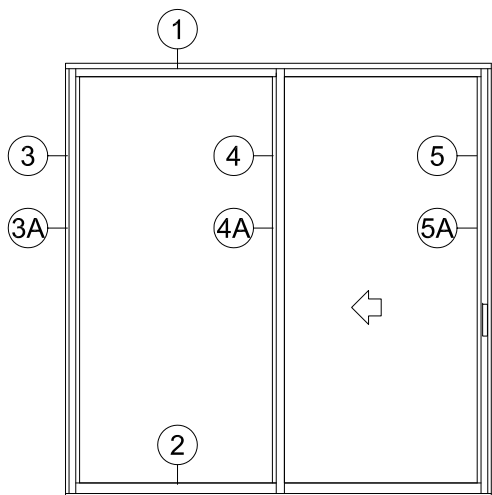
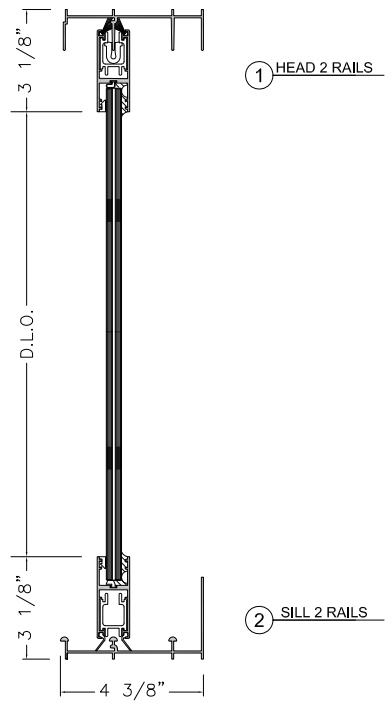

HORIZONTAL SECTIONS

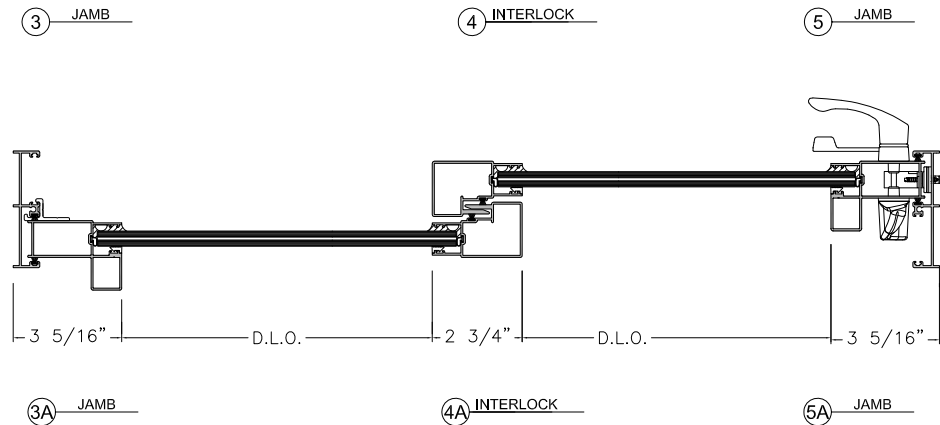
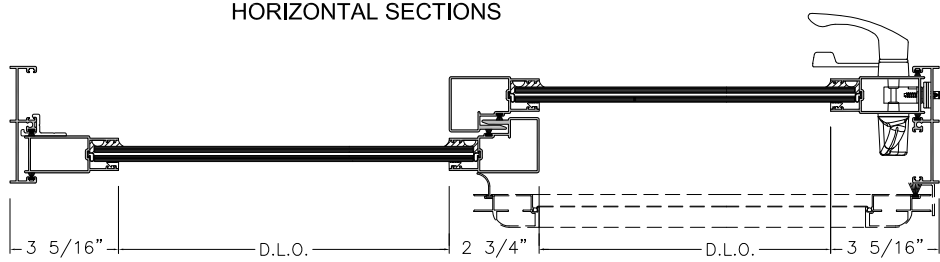

VERTICAL SECTIONS

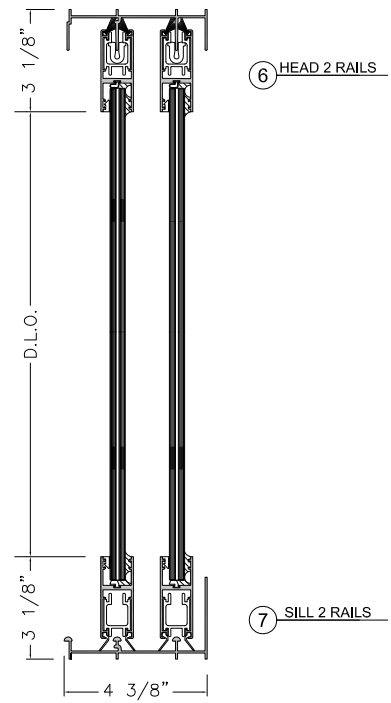

ENERGÍA SOLAR
ESWINDOWS

OXO

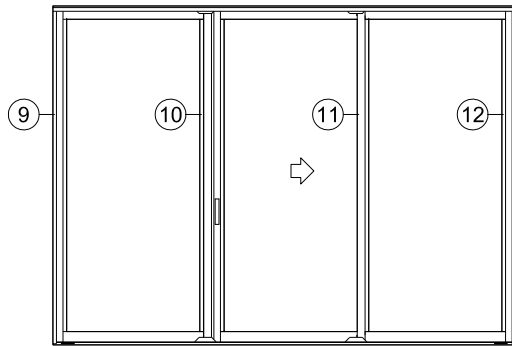

HORIZONTAL SECTIONS

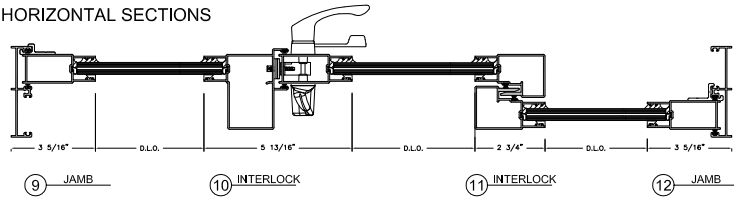

OXXO

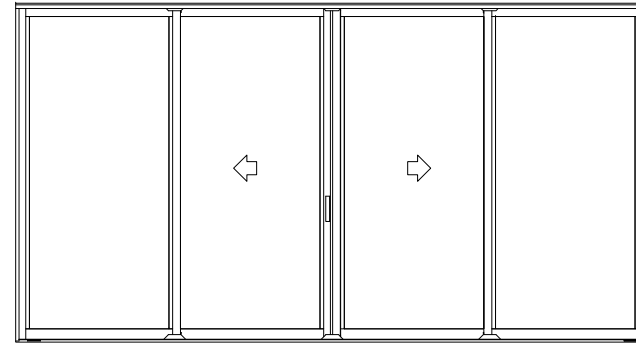

HORIZONTAL SECTIONS

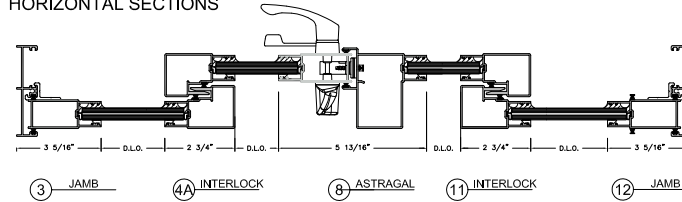

ELEVATIONS

XXX

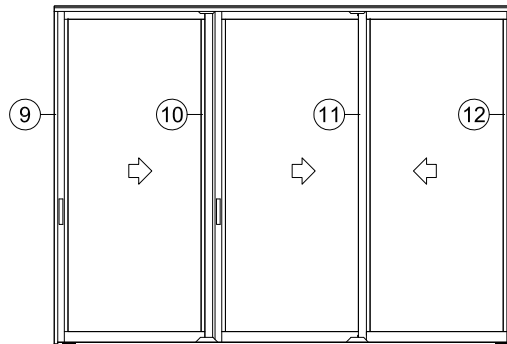

HORIZONTAL SECTIONS

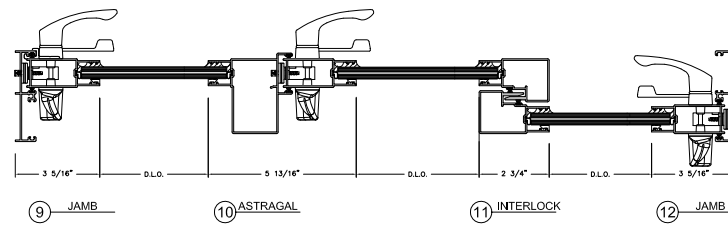

XXXO

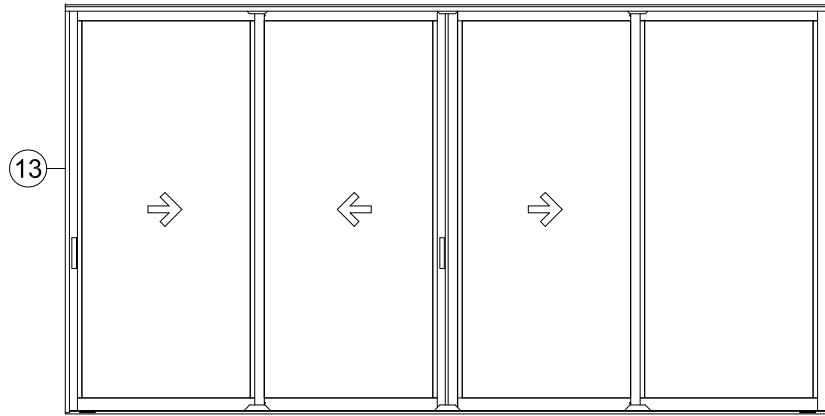

XXXX

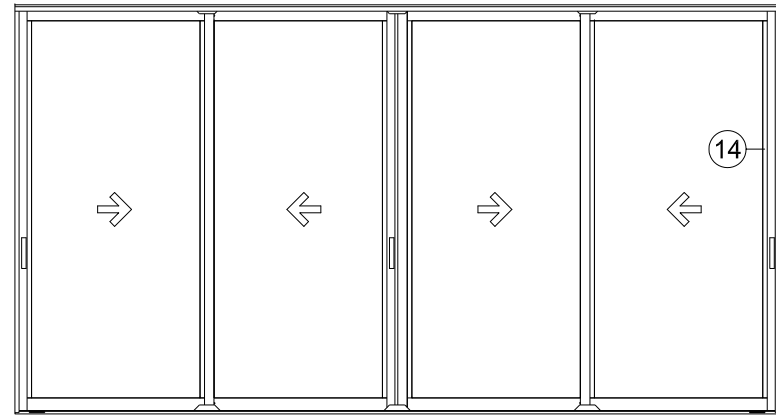

HORIZONTAL SECTIONS

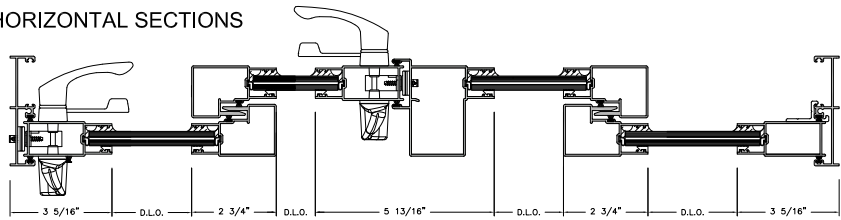

- 13** JAMB
- 4A** INTERLOCK
- 8** ASTRAGAL
- 11** INTERLOCK
- 12** JAMB

HORIZONTAL SECTIONS

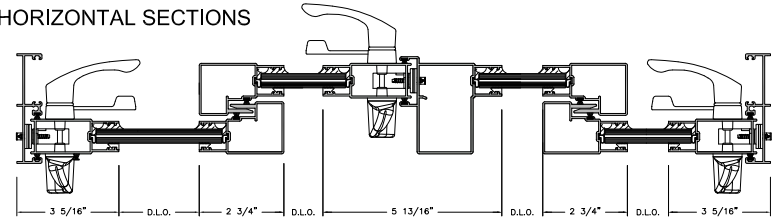

- 13** JAMB
- 4A** INTERLOCK
- 8** ASTRAGAL
- 11** INTERLOCK
- 14** JAMB

OXX

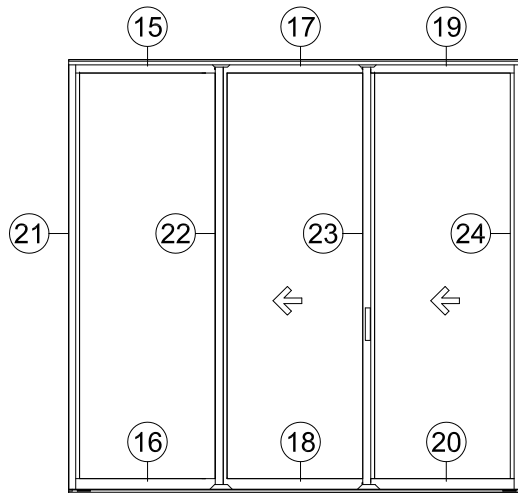

HORIZONTAL SECTIONS

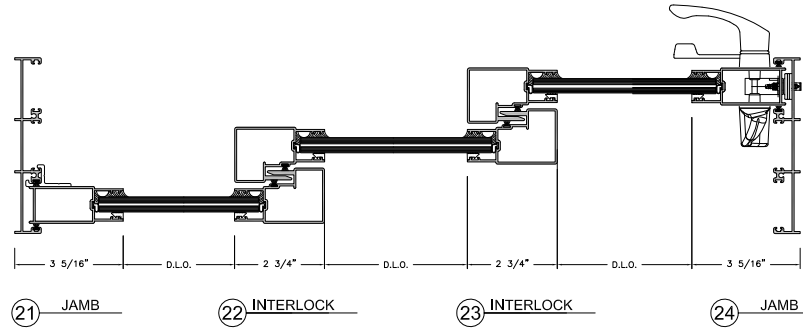

VERTICAL SECTIONS

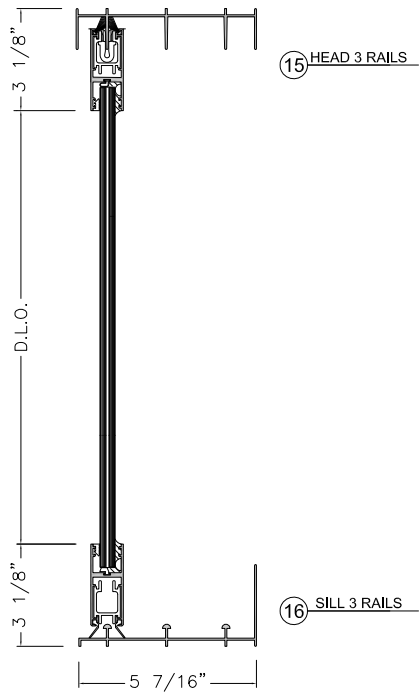

VERTICAL SECTIONS

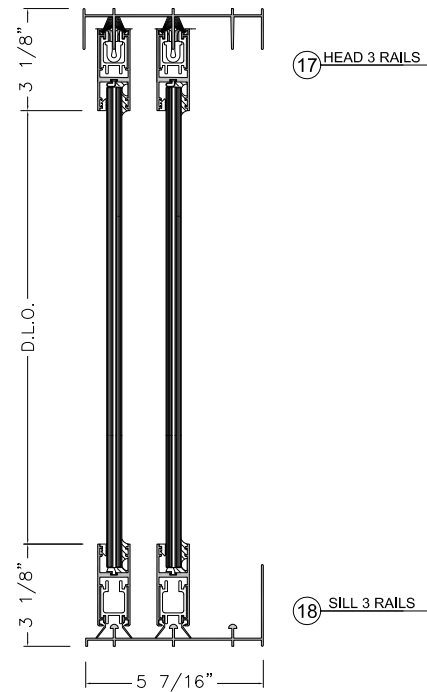

VERTICAL SECTIONS

