

500Y



HSEQ REGULATIONS

Read all instructions carefully before attempting this procedure. If you have any questions about your ability to complete this procedure, contact ESWINDOWS for further direction.

If swing stages are required for installation, the HSEQ inspector must approve the permissions.

- Wear the necessary personal protective equipment for product installation.
- Take safety precautions when performing the activity.
- Please follow the steps and make sure you have appropriate personal protective equipment and follow the rules established by the guidance for working at height, if required to do so.

INTRODUCTION

500Y is a hung window system.

This guide illustrates step by step the correct way to install the system.

Prior to installation check that all parts, glass and materials are in right conditions, verify that the quantities and descriptions match production planes.

INSTALLATION INSTRUCTIONS

TOOLS AND SUPPLIES REQUIRED FOR INSTALLATION..... Page. 2
PARTS REQUIRED FOR INSTALLATION..... Page. 3

STEPS

STEP 1
Inspection and Verification..... Page. 4

STEP 2
Remove vent..... Page. 5-7

STEP 3
Install frame..... Page. 8-12





STEP 4
Install vent Page. 13-15





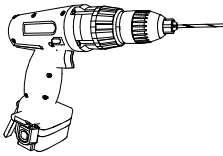
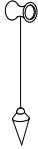
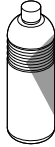
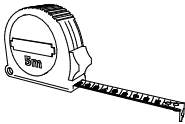

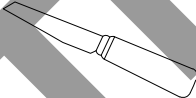
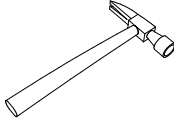
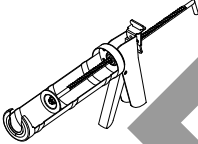
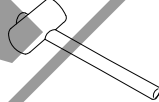
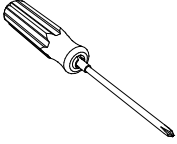
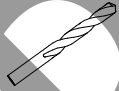
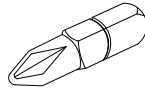
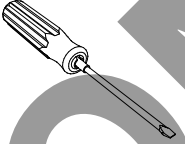
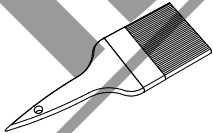
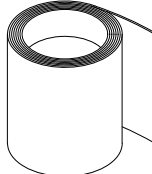
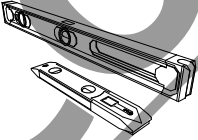
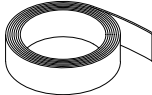
STEP 5
Install Covers Page. 16

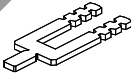
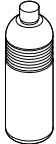
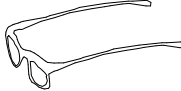
STEP 5
Seal perimeter..... Page. 17

REVISIONS

TOOLS AND SUPPLIES FOR INSTALLATION

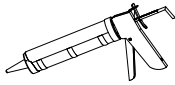
Detail	Description	Detail	Description	Detail	Description
	Drill		Plumb		Thinner
	Measure tape		Thread		Knife
	Hammer		Industrial Silicone gun		Mallet
	Phillips screwdriver		Bits for concrete		Point
	Slot screwdriver		Brush		Clean rag
	Level		Masking tape		Safety gloves
	Plastic shims		Isopropyl alcohol		Safety glasses

PARTS REQUIRED FOR INSTALLATION		
PART	DETAIL	DESCRIPTION
500Y-010		SINGLE HUNG FRAME INSTALLATION TRACK COVER
500Y-013		VENT STOP FOR SINGLE HUNG 500Y SERIES
500Y-023		1" X 5" SINGLE HUNG MULLION
500Y-024		FEMALE ANCHOR CLIP
500Y-025		MALE ANCHOR CLIP
D.C 791		WEATHERPROOFING SEALANT
#10 x 1/2" LG.PH		WINDOW TO MULLION



Check the technical manuals and guides by sealant manufacturers to apply silicone correctly.

STEP 1

INSPECTION AND VERIFICATION :

- 1.1 The rough opening should be checked for the correct size as determined by dimensions listed in the architectural specifications and the shop drawings. Measure rough opening in several places to determine variations. Correct as necessary.
- 1.2 Check all the material upon arrival for quantity and damage.
- 1.3 Remove any debris that interferes with the proper installation of the unit.
- 1.4 Notify ES-WINDOWS for any irregularities.

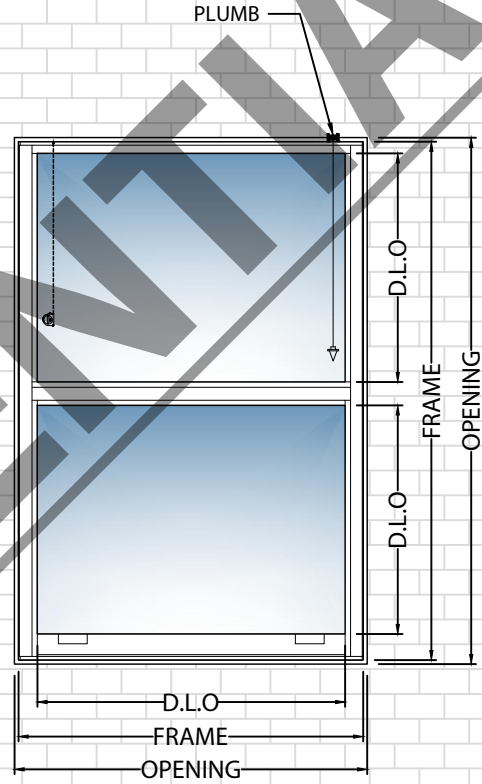

STEP 2

REMOVE VENT

2.1. Remove the sash stops from both sides of the window (Detail A).

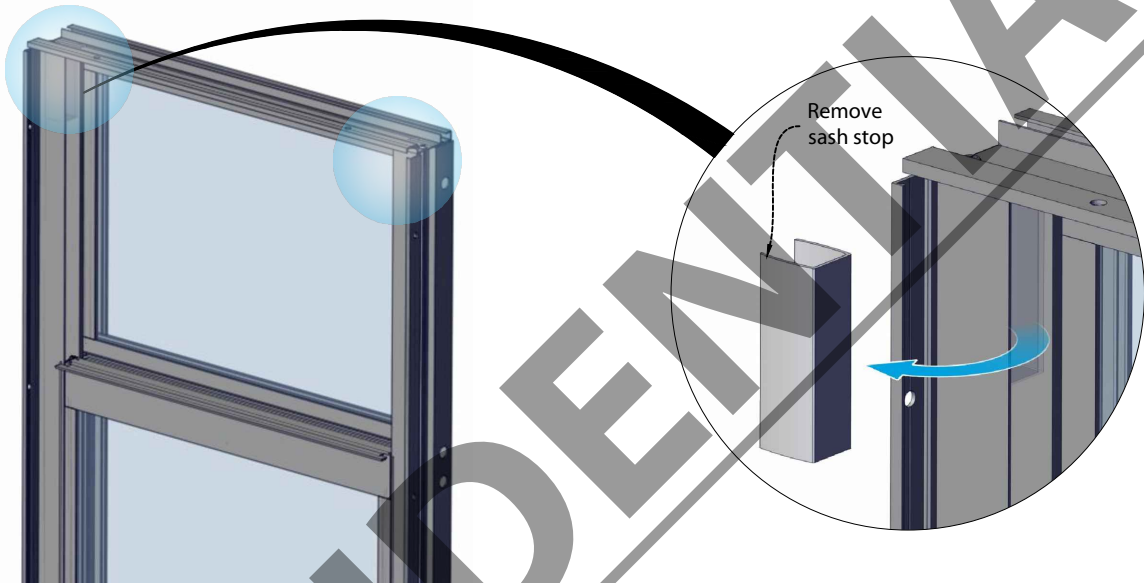

2.2. If required, remove plastic guides on each side of the vent top.

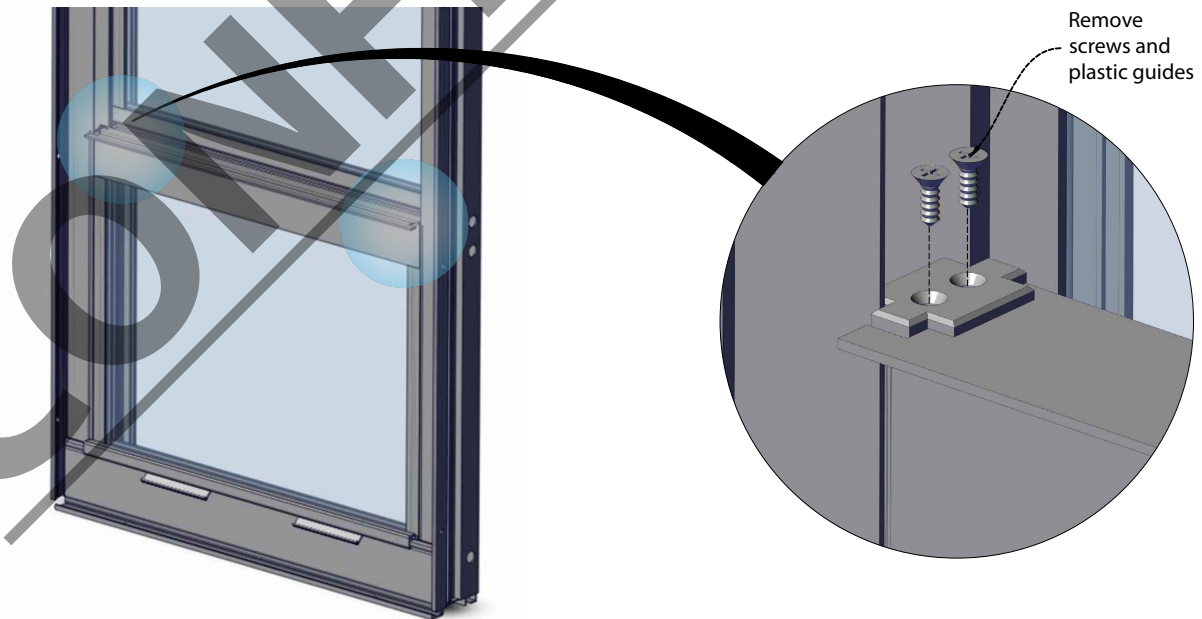

2.3. Unlock finger lock to open the window and bring sash to open position.

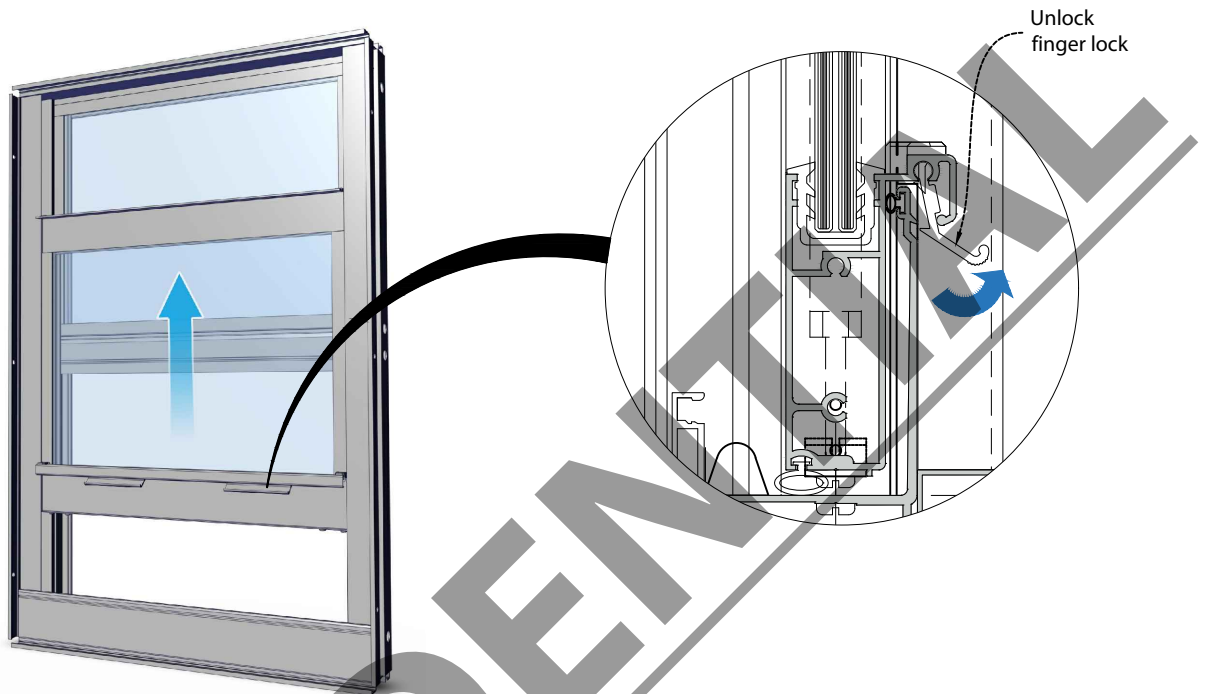

2.4. Prior to disengagement, make sure to properly secure sash in position to avoid breakage. Disengage spiral balance by removing non tilt bracket screws.

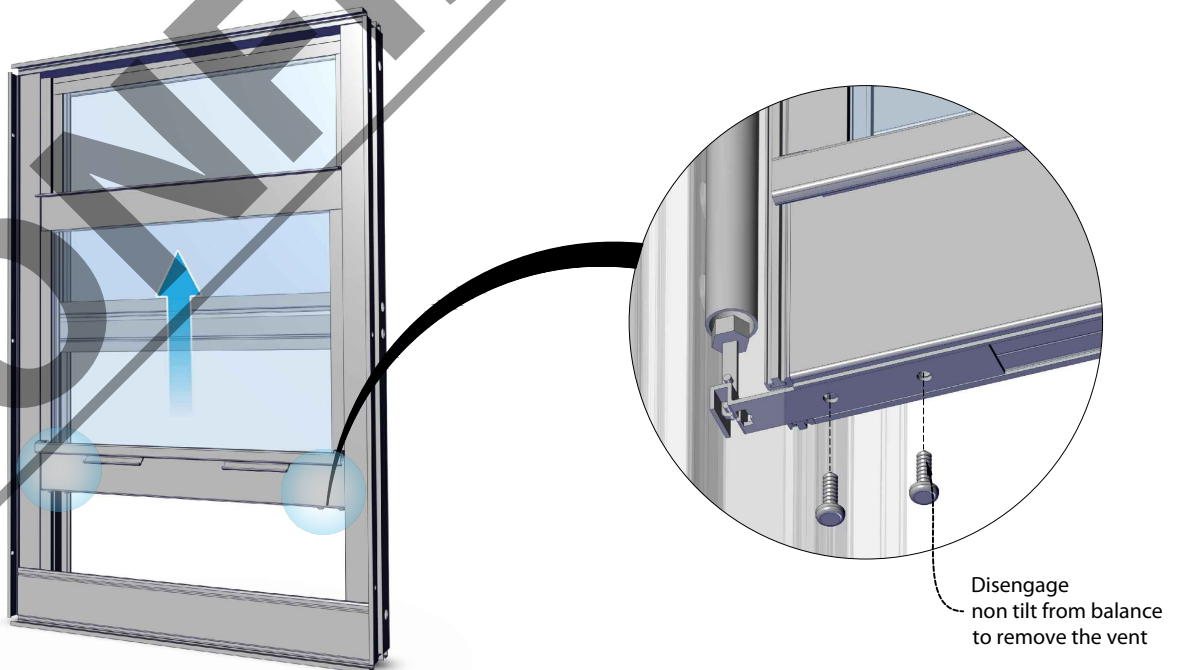

2.5. Remove vent as shown in detail bellow.

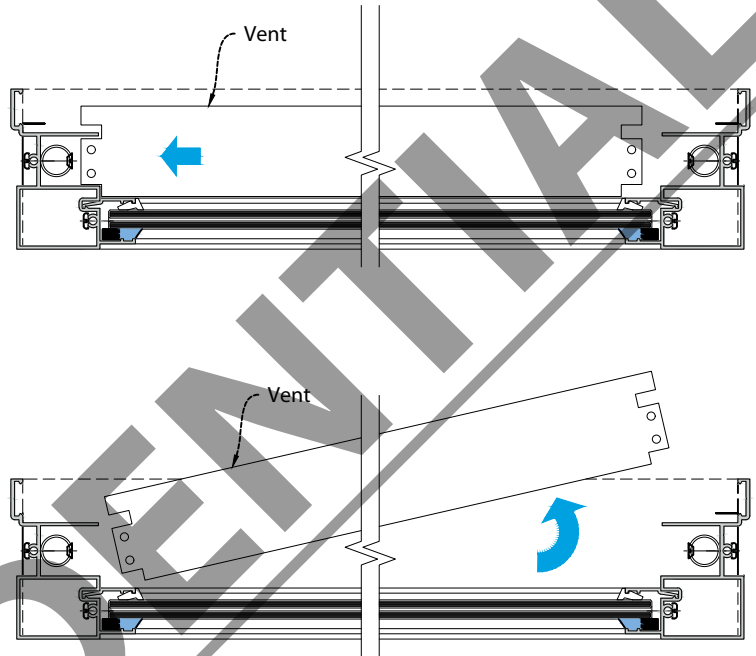

CONFIDENTIAL

STEP 3

INSTALL FRAME:

STEPS TO INSTALL STAND ALONG FRAME:

- 3.1. From outside of the building place the window in the opening. Level, plumb and square the window, using hi-impact plastic shims.

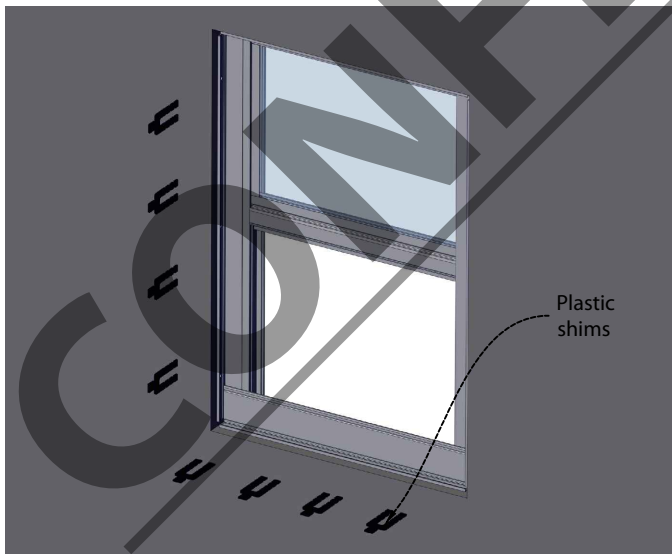
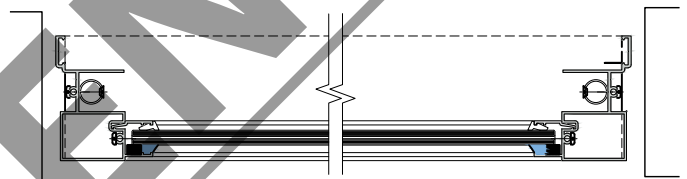
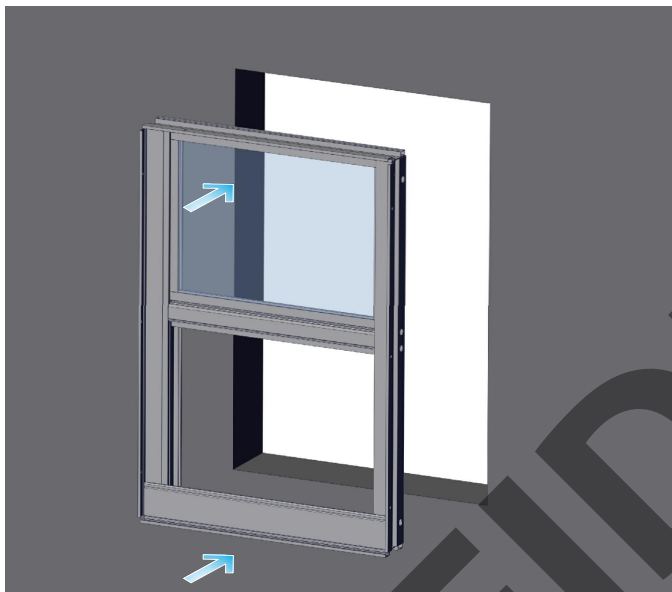

3.2. Use pre-fabricated holes as a guide to drill and install anchor screws.

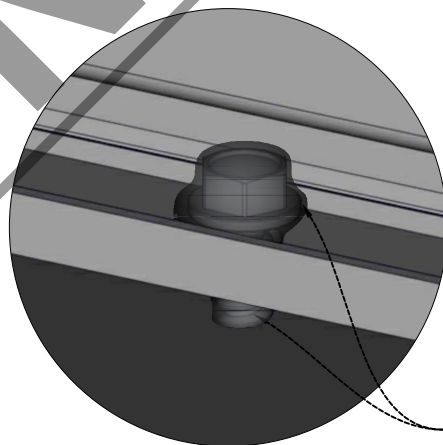
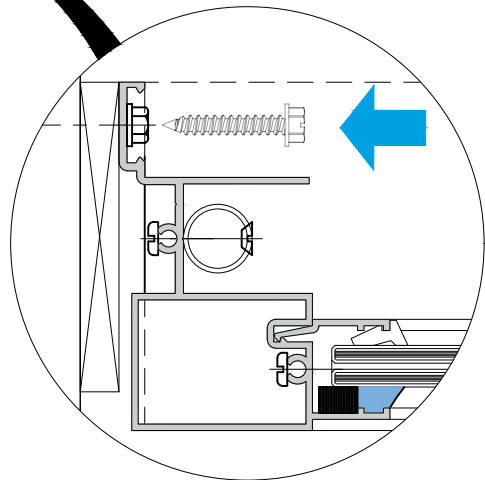
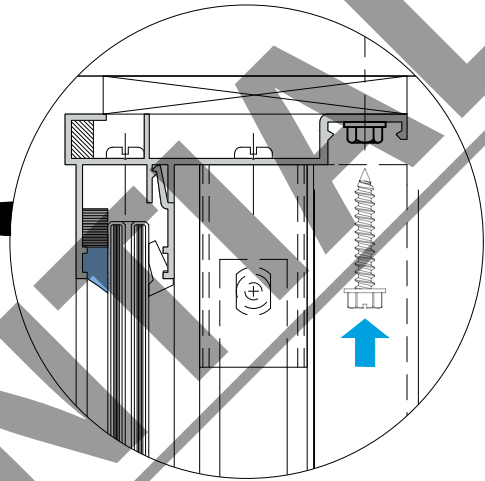

D.C 791
Weatherproofing
sealant

INSTALLATION OF DOUBLE HUNG WINDOW:

- 3.3. Window assembly: Insert anchors into the mullion as shown in detail A. Attach windows to mullion with #10 X 1/2" LG.PH. screws.

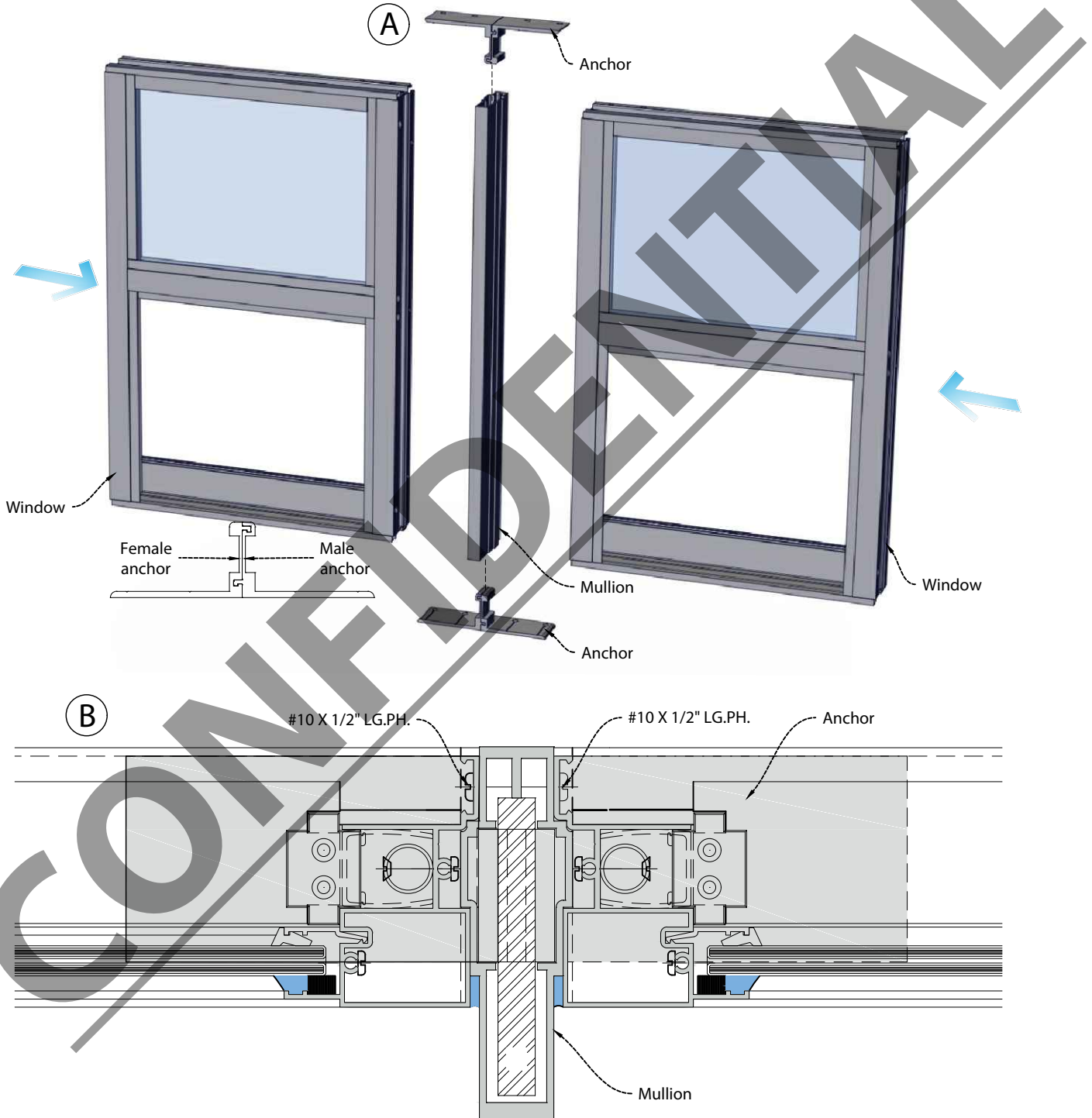

3.4. Place window in the opening and shim as required.

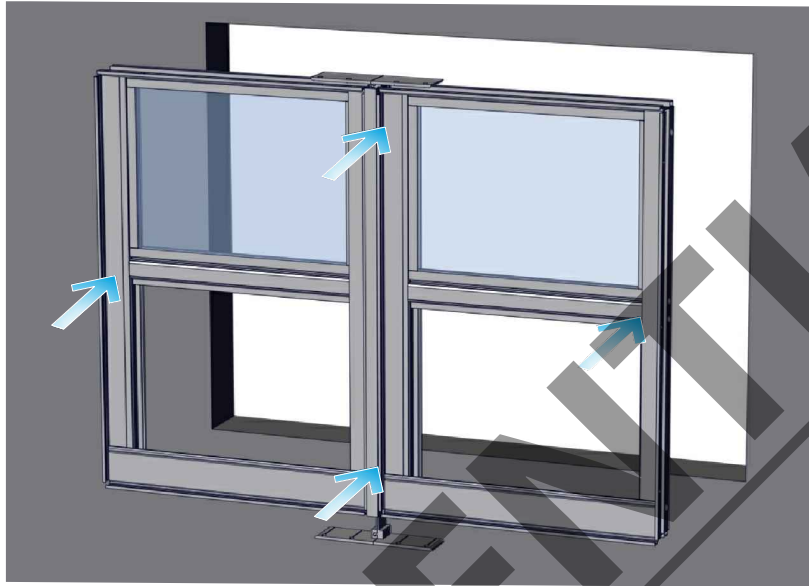

3.5. Verify the sureness and the leveling of the window. Install screws through access holes.

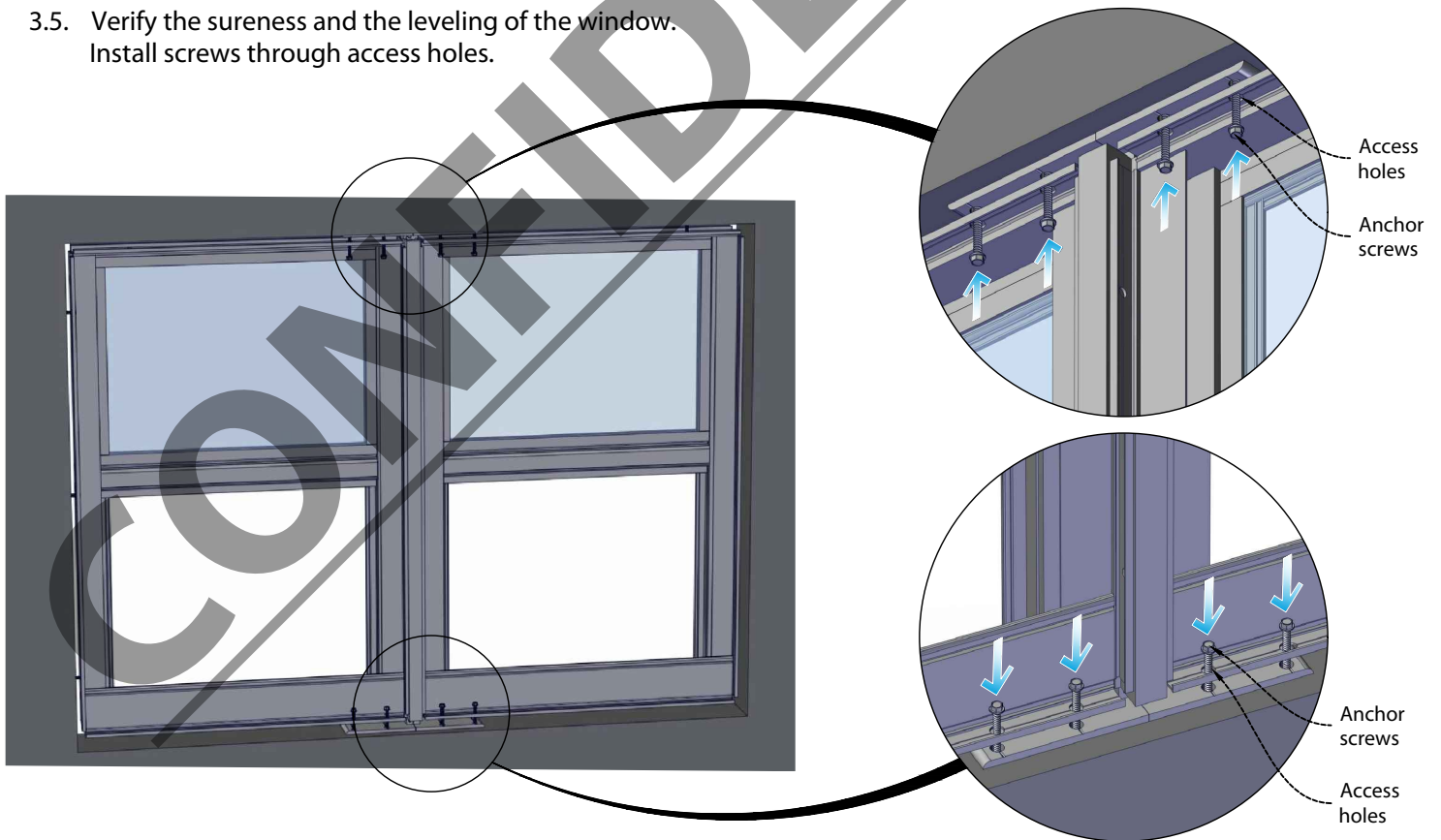

3.6. Use prefabricated holes as a guide to install anchor screws.

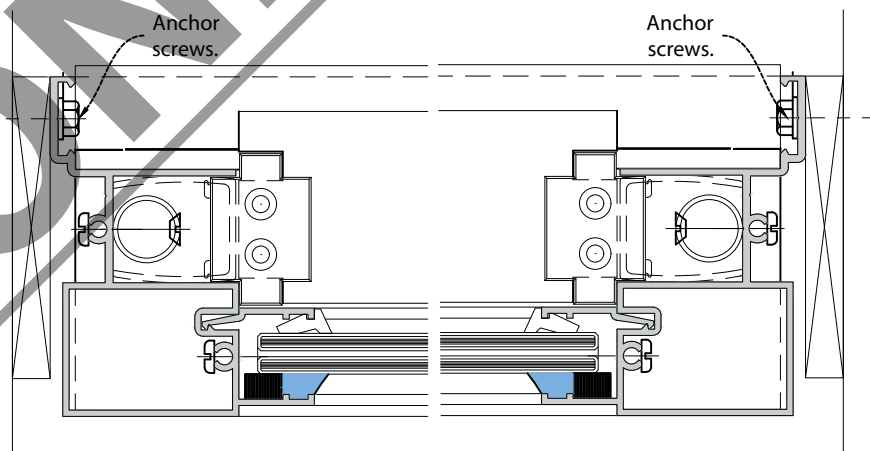

STEP 4

INSTALL VENT:

4.1. Working from the interior of window install vent as shown in detail below.

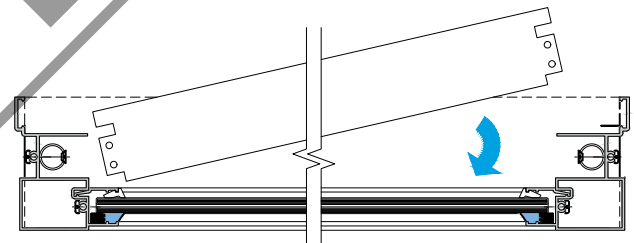
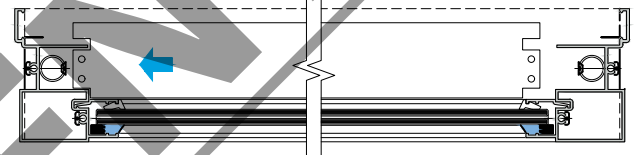

4.2. Re-install non tilt balance brackets (use screws from steps 2.4).

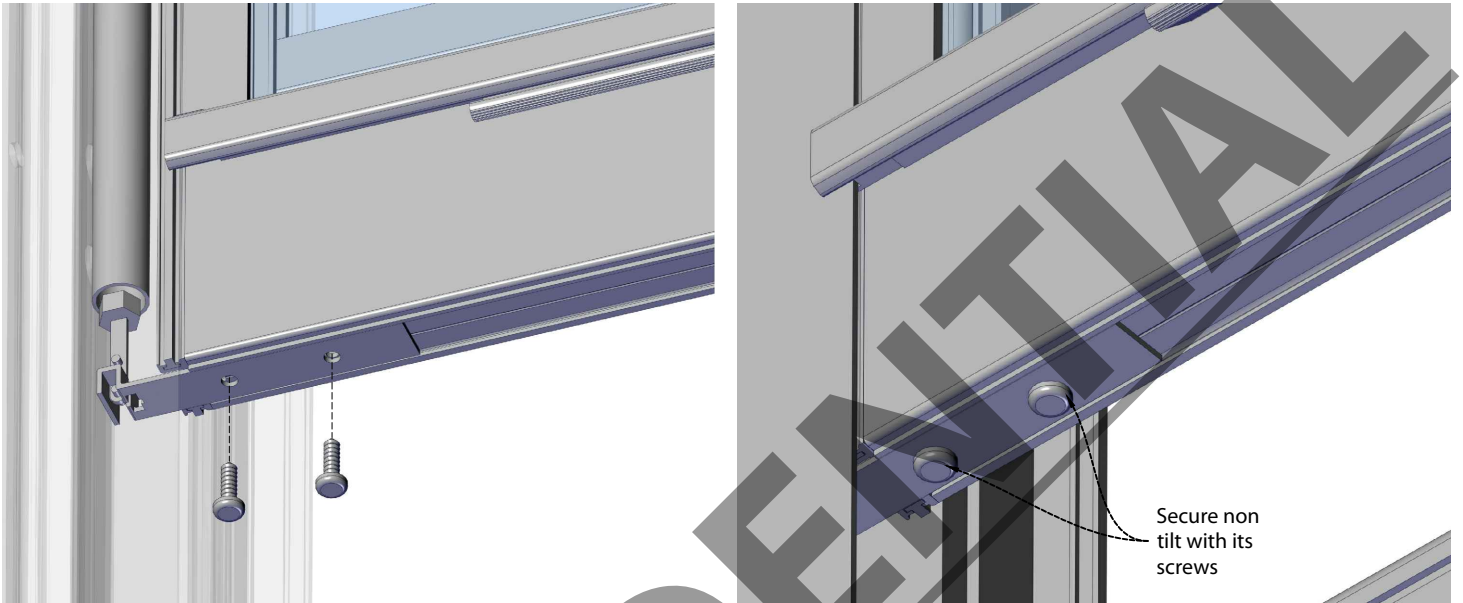

4.3. Install plastic guides on both sides of the vent.

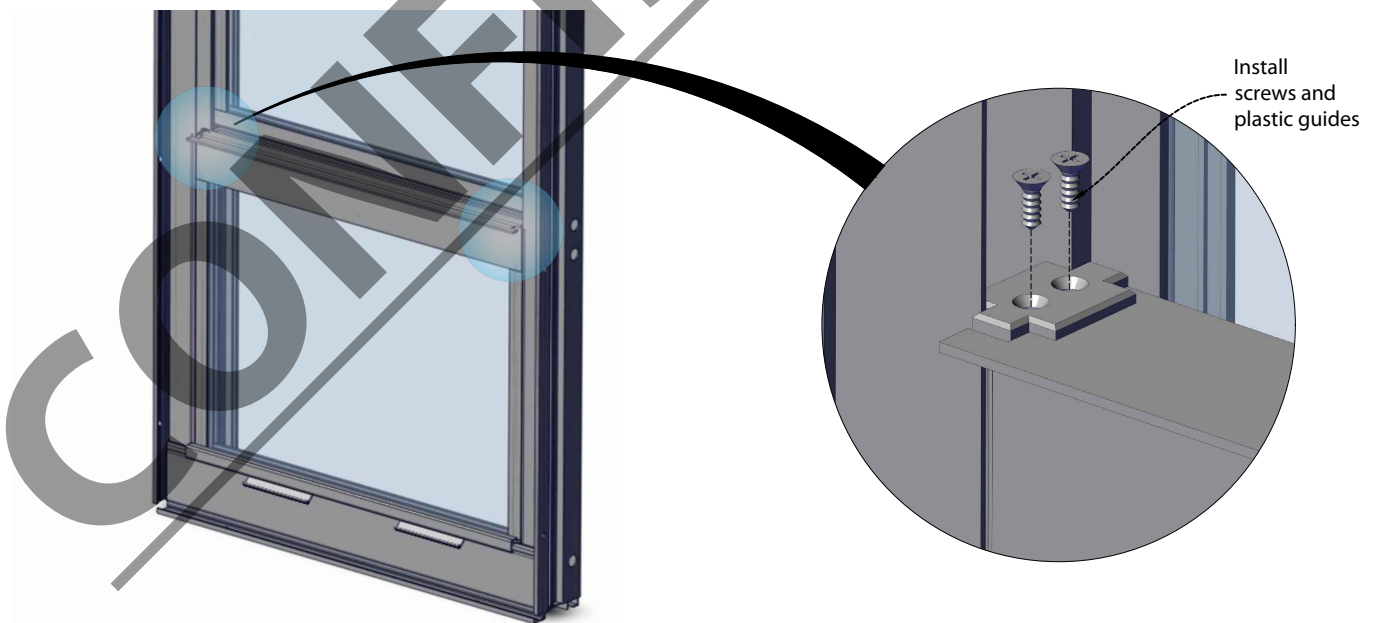

4.4. Verify the correct functionality of the balances. Close the window and secure it with the finger locks.

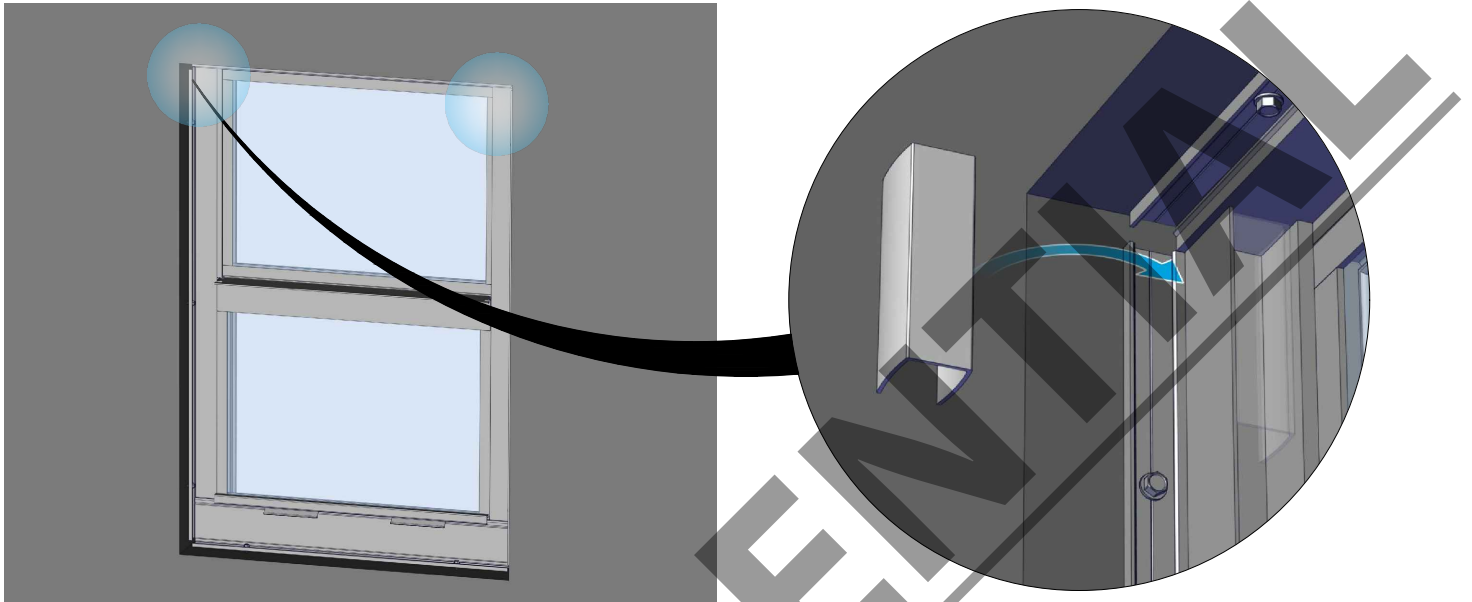

4.5. Verify functionality of the window. Open and close the window at least 4 times.

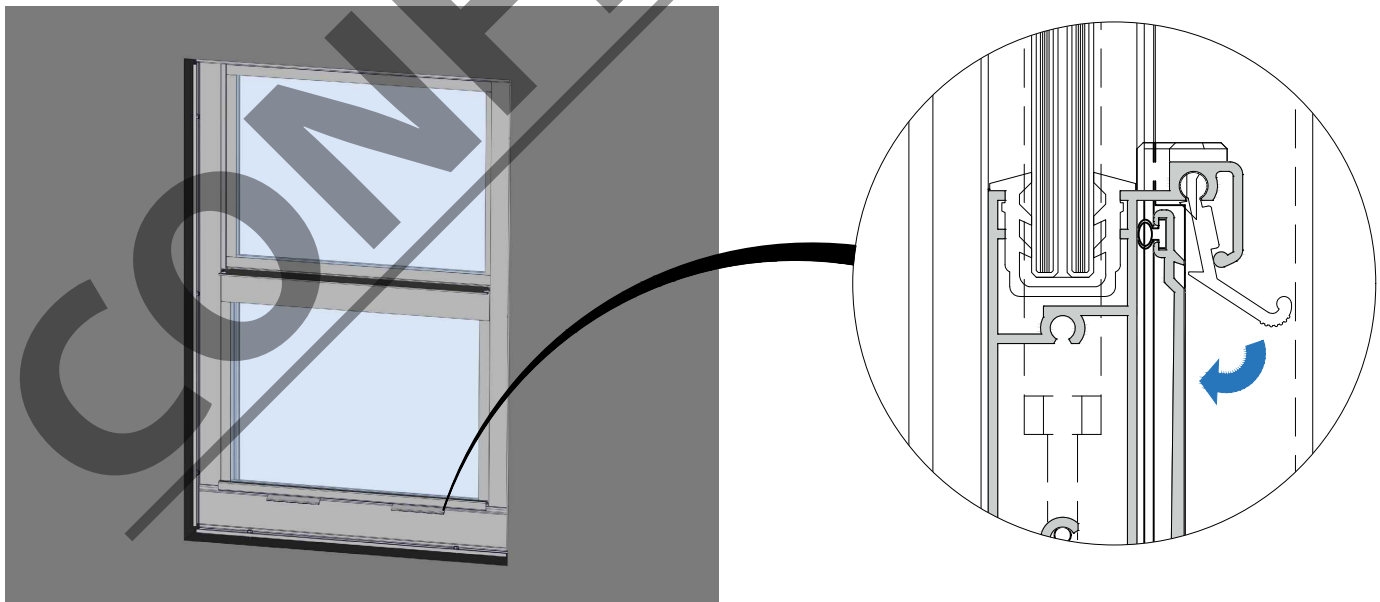

STEP 5

INSTALL COVERS:

- 5.1. First install horizontal covers and then vertical covers 500Y-010. Seal joints between covers with weatherproofing sealant.

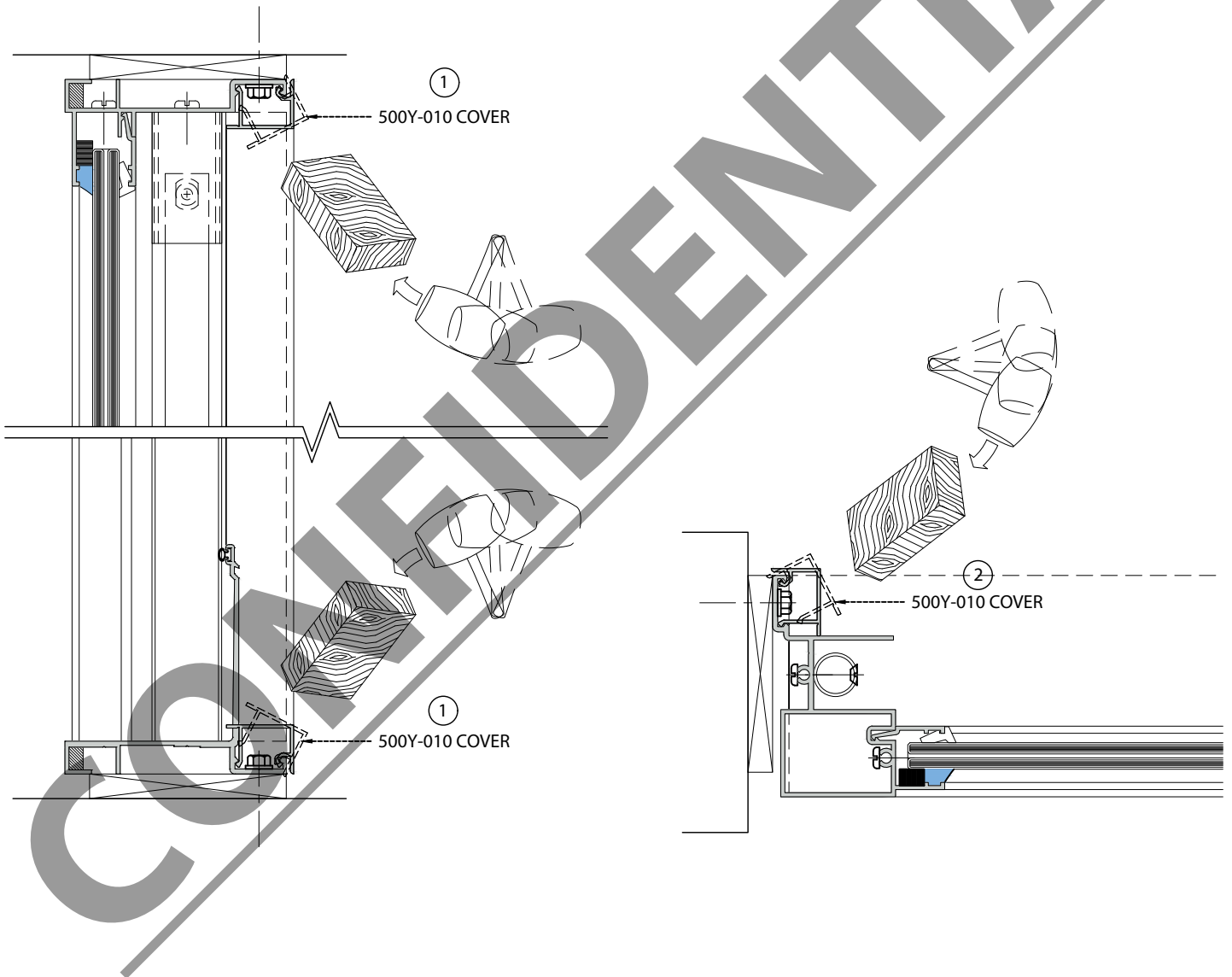

STEP 6

SEAL WINDOW PERIMETER:

- 6.1. Properly clean windows surface that will be in contact with silicone. Insert backer rods and apply weatherproofing sealant to frame perimeter.

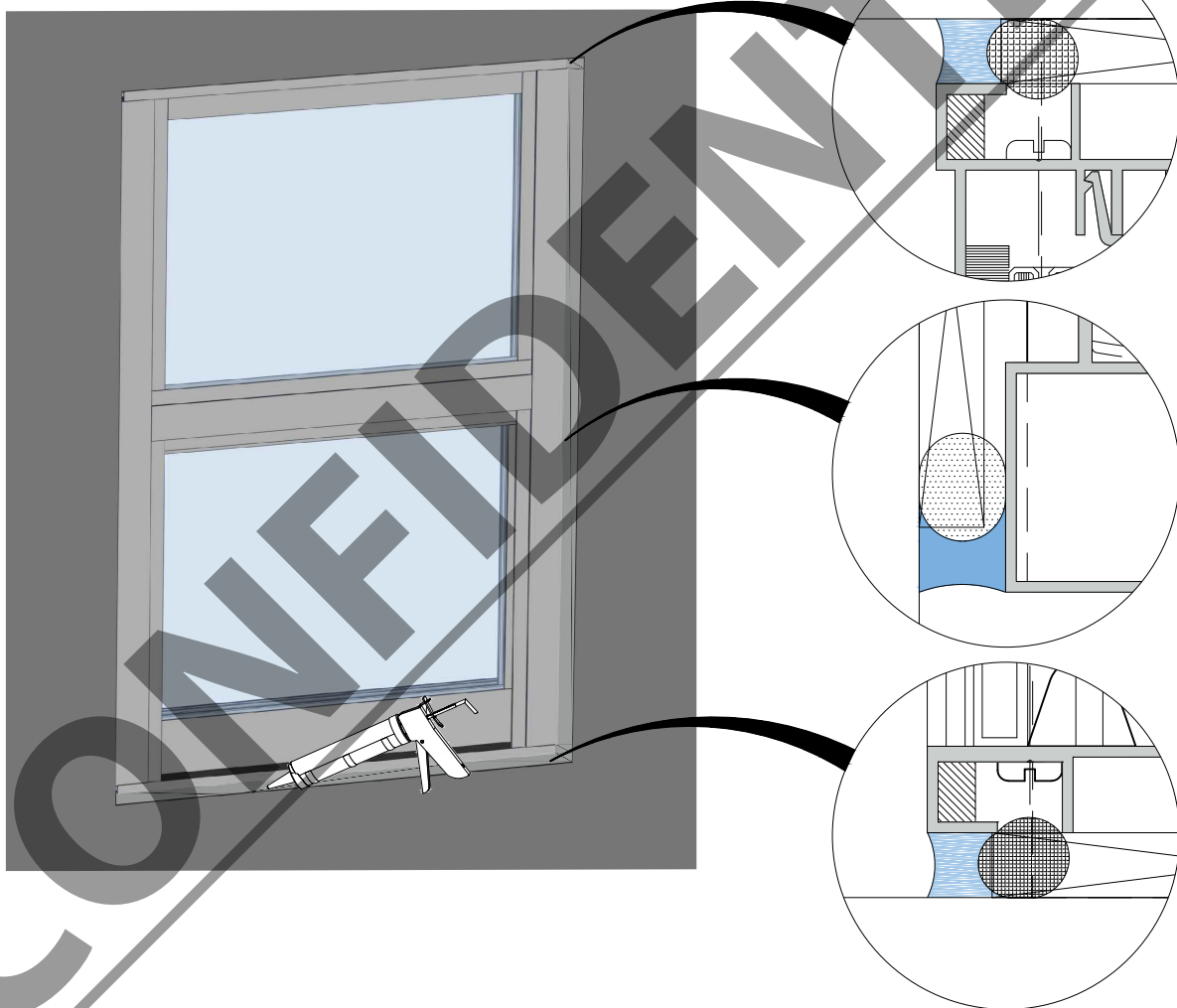

REVIEW No.	DATE	DESCRIPTION	PAGE.	BY
△				
△				
△				
△				
△				
△				
△				
△				
△				
△				

CONFIDENTIAL

CONFIDENTIAL

Av. Circunvalar a 100 mts de la Via 40 Las Flores
Barranquilla, Colombia PBX: (57 5) 3664600
service@eswllc.com, PBX: (+1) 305 5074545

BY Sariel González.