

ES-8000T

STOREFRONT

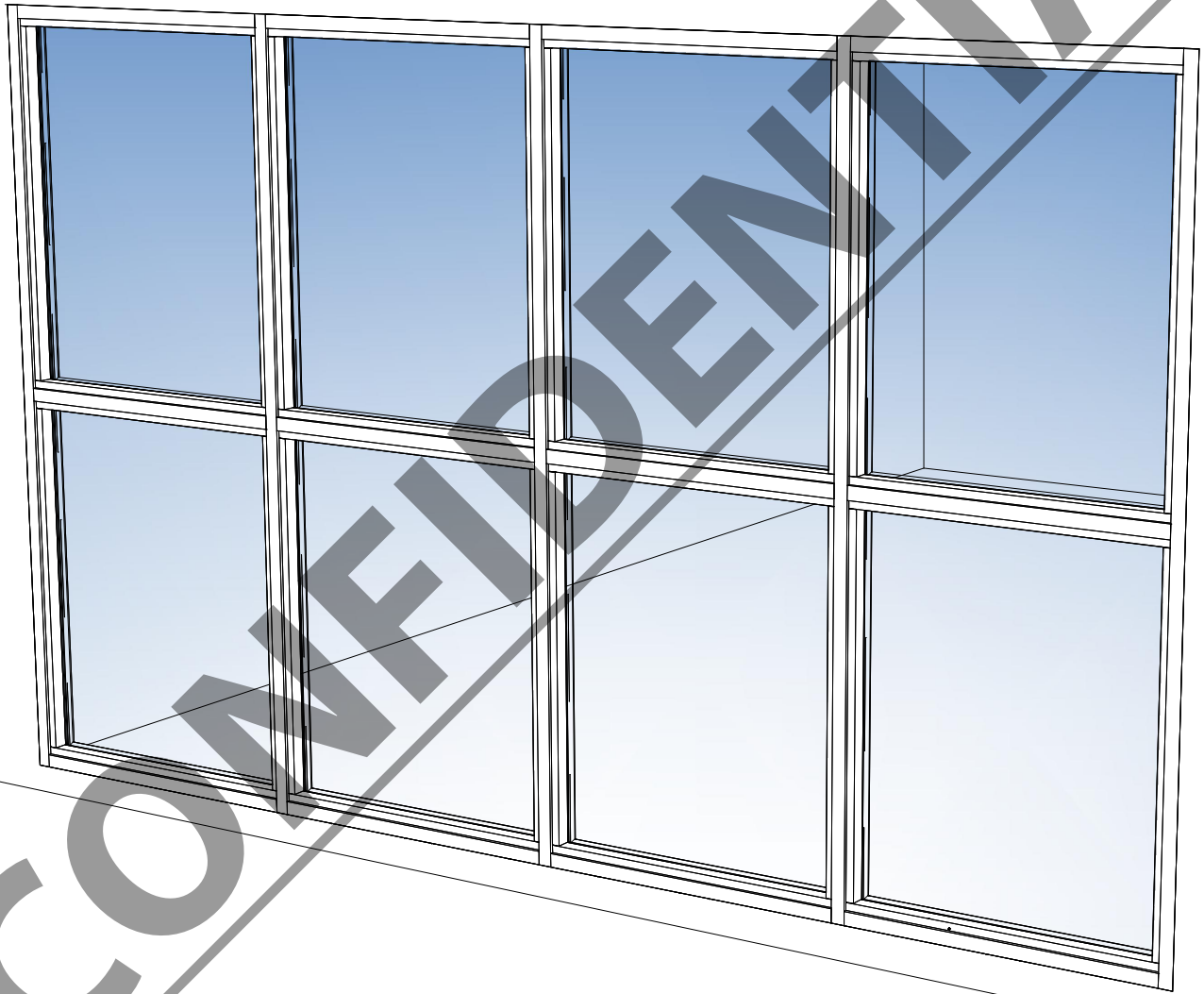

ENERGÍA SOLAR
ESWINDOWS

HSEQ REGULATIONS

Read all instructions carefully before attempting this procedure. If you have any questions about your ability to complete this procedure, contact ESWINDOWS for further direction.

If the need of swing stages is required for installation, the HSEQ inspector must approve the permissions.

- Wear the necessary personal protective equipment for product installation.
- Take safety precautions when performing the activity.
- Please follow the steps and make sure you have appropriate personal protective equipment and follow the rules established by the guidance for working at height, if required to do so.

INTRODUCTION

ES-8000T system is a storefront system.

This guide illustrates step by step the correct way to install the system.

Prior to installation check that all parts, glass and materials are in right conditions, verify that the quantities and descriptions match production planes.

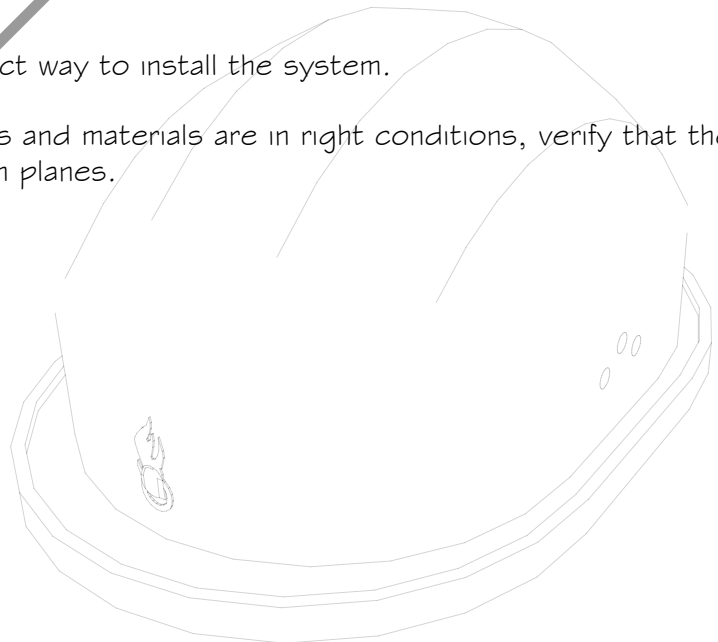

INSTALLATION INSTRUCTIONS

HSEQ AND INTRODUCTION.....Page. 1

DESCRIPTION OF PARTS

TOOLS AND SUPPLIES REQUIREDPage. 3
PARTS REQUIRED.....Page. 4

INSTALLATION

STEP 1
Inspection and verification.....Page. 5

STEP 2
Installation of units.....Page. 6-8







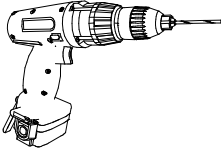

STEP 3
Glass stop installation.....Page. 9

STEP 4
Seal perimeter.....Page. 10

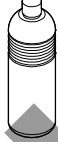
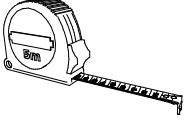

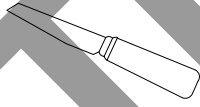
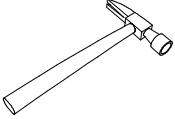
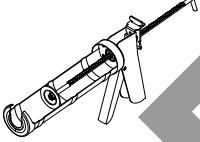
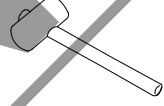
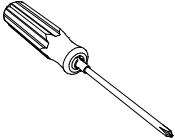
REVISIONS

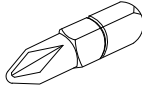
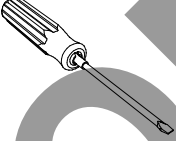
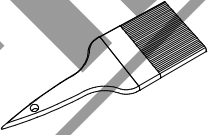
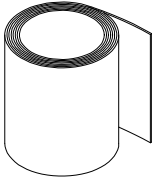
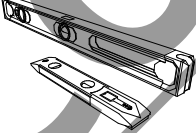
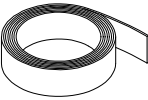
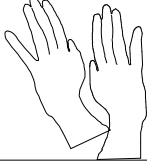
CONFIDENTIAL

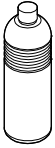
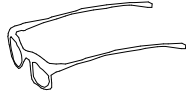
TOOLS AND SUPPLIES REQUIRED FOR INSTALLATION

DETAIL	DESCRIPTION	DETAIL	DESCRIPTION	DETAIL	DESCRIPTION
	Drill		Plumb		Thinner
	Tape Measure		Thread		Knife
	Hammer		Silicone Gun		Rubber Hammer
	Phillips Screwdriver		Bits for Concrete		Points
	Slot Screwdriver		Brush		Clean rag
	Level		Masking tape		Gloves
	High impact plastic shims		Isopropyl Alcohol		Safety Glasses

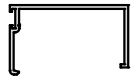
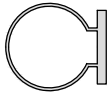
ES-8000T PARTS REQUIRED FOR INSTALLATION

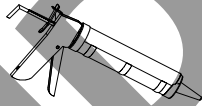
PARTS		DESCRIPTION
EXTRUSIONS		
ES-8000T-005		GLASS STOP
27-431		PERIMETER GASKET
1/4"(Diameter) x 2 1/8"		BOLT WITH NUTS
SILICONE D.C 791		WEATHERPROOFING SEALANT



Check the technical manuals and guides by sealant manufacturers to apply silicone correctly.

STEP 1

INSPECTION AND VERIFICATION:

- 1.1. The opening should be checked for the correct size as determined by dimensions listed in the architectural specifications and the shop drawings.
- 1.2. Check all the material upon arrival for quantity and damage.
- 1.3. Remove all materials that could interfere with the proper installation of the window.
- 1.4. If you have any irregularities notify the general contractor.

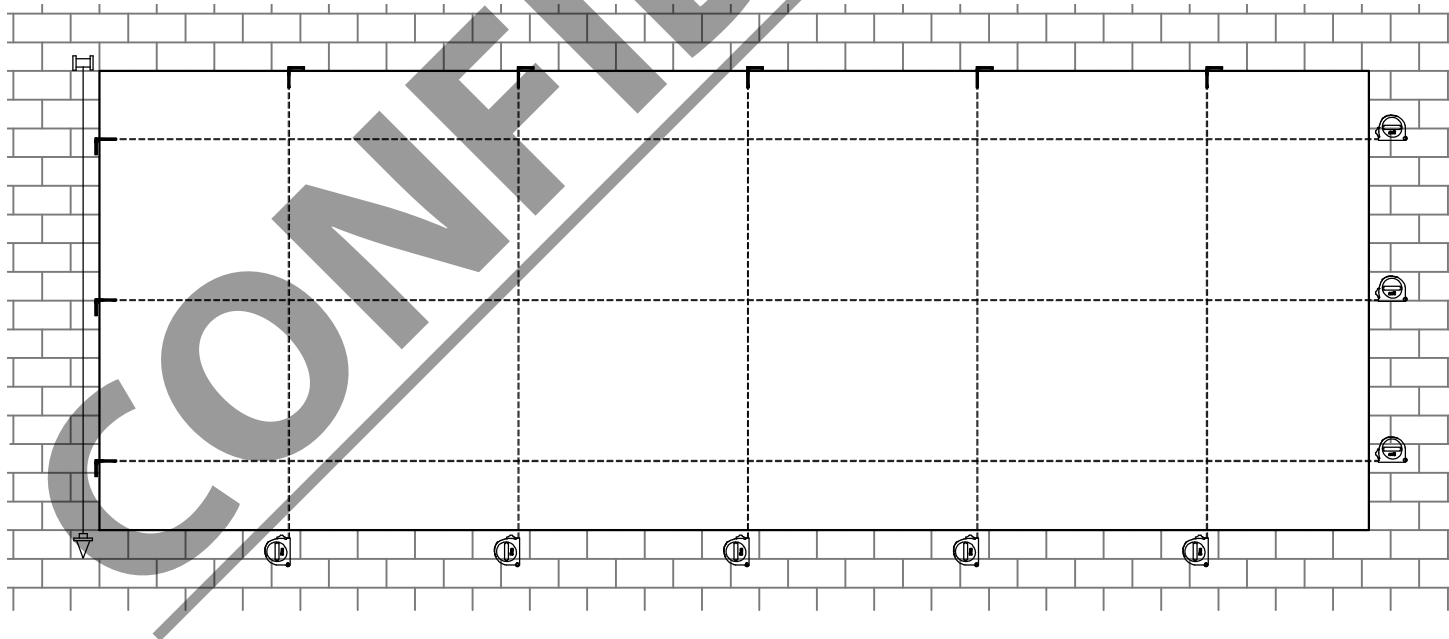
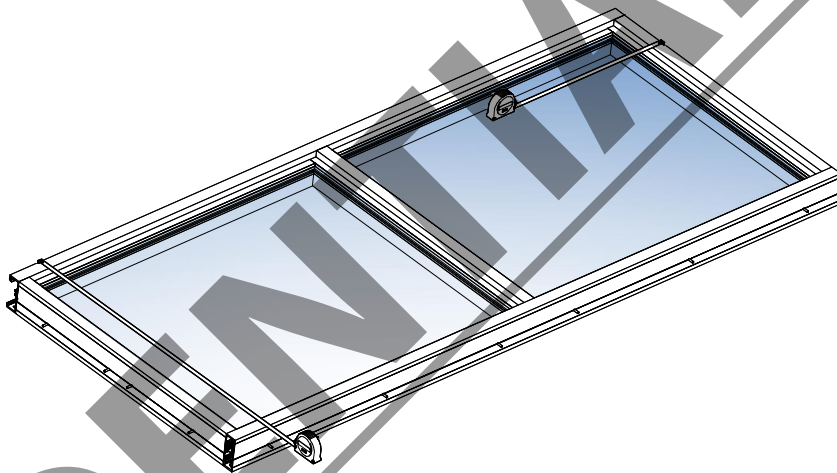

STEP 2

INSTALLATION OF UNITS:



In order to prevent any accidents make sure to work with the required equipment and enough manpower to support the units.



Units must be installed as per shop drawings; shop drawings should abide NOA'S anchor and pressure tables.

- 2.1. Clean the opening and the window frame surfaces.
- 2.2. Locate units using provided marks.
- 2.3. Working from the inside, shim as required. It is recommended the use of high strength plastic or non-corrosive shims.(Detail 2.3)
- 2.4. Install anchors using pre-drilled holes in the frame.(Detail 2.4)

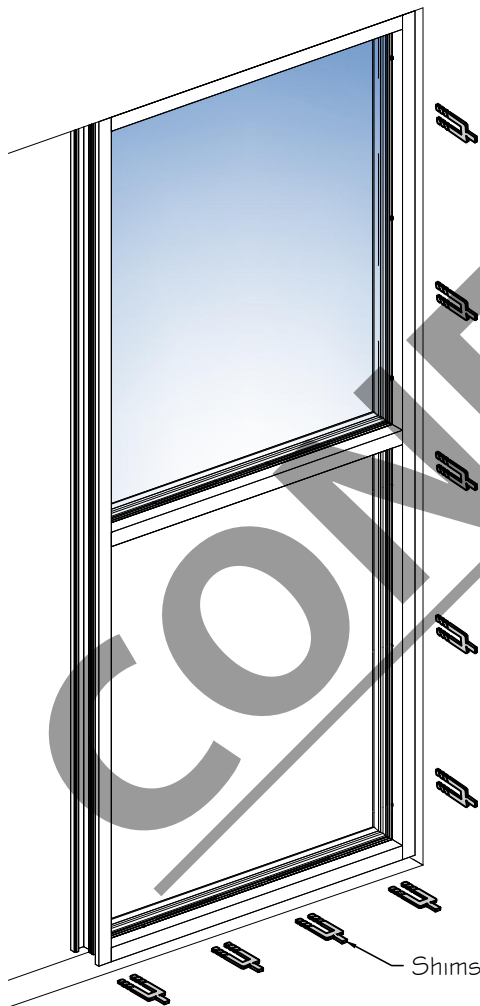

DETAIL 2.3

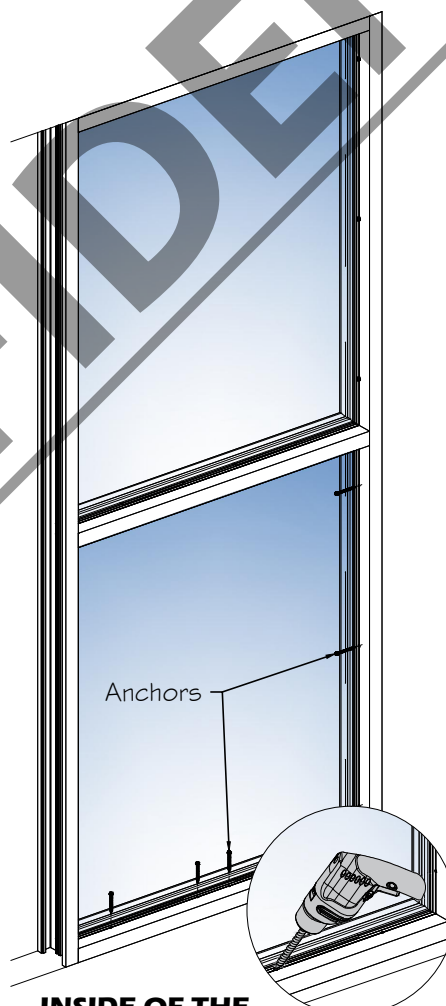

INSIDE OF THE BUILDING

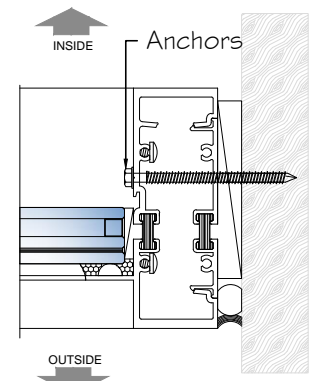
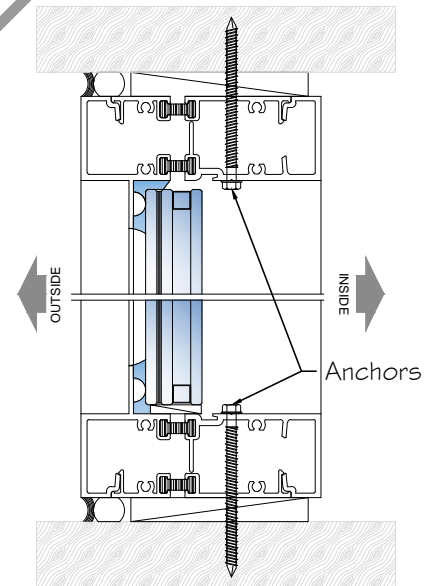

DETAIL 2.4

FOR SNAPPING TWO OR MORE UNITS:

- 2.5. Prior to snapping the units together, apply weatherproofing sealant to the joint surfaces along the vertical mullion. (Detail 2.5).
- 2.6. Snap the units carefully and make sure that the units where completely sealed by the weatherproofing sealant. (Detail 2.6).
- 2.7. Mullions must be fastened together using a 1/4" x 2 1/8" bolt, at 6" from ends and 18 1/2" Max. O.C. (Detail 2.7).

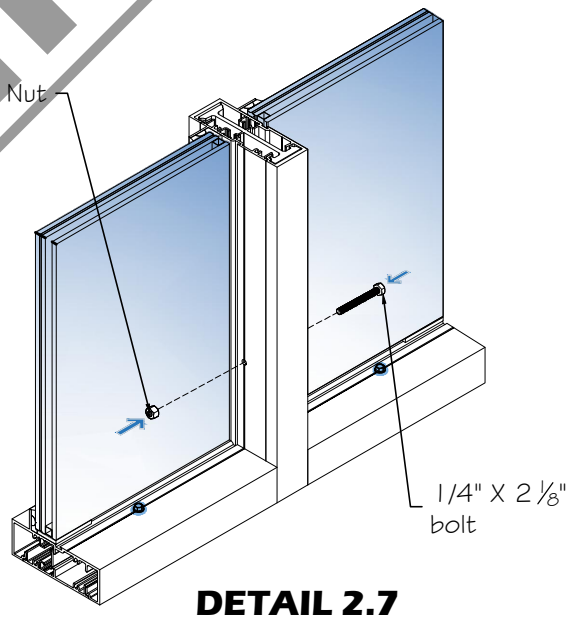
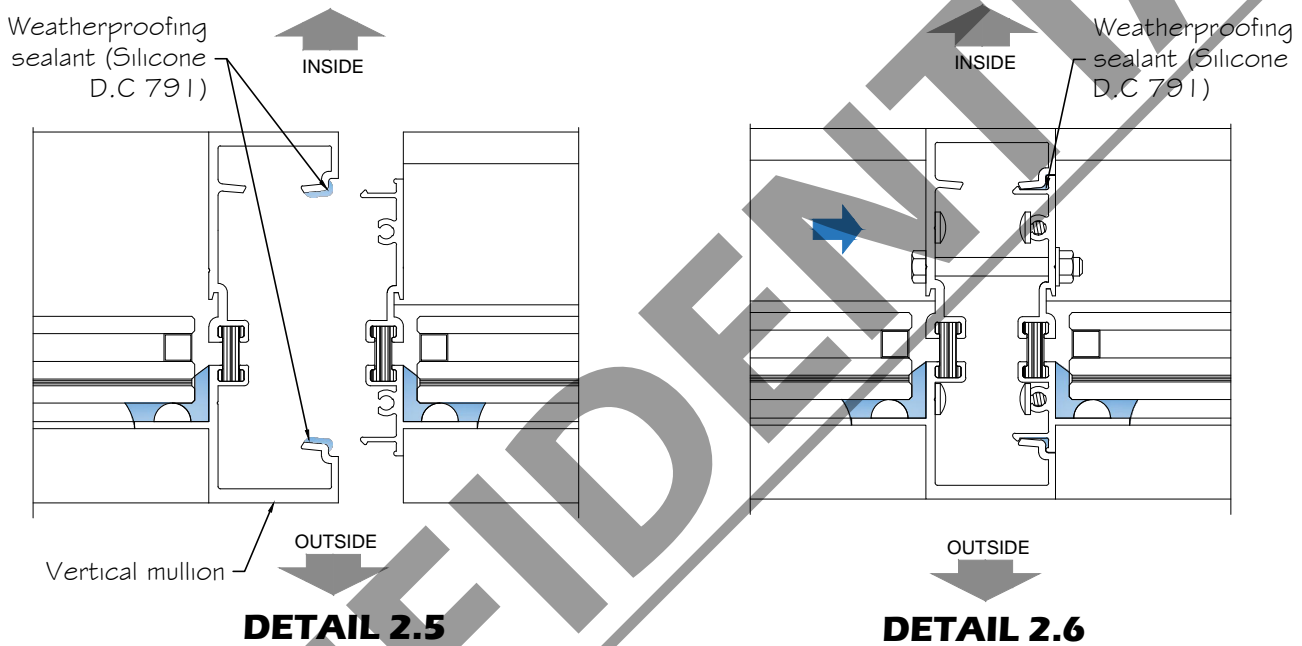

2.8. The last two units should be installed together in order to be able to snap. (Detail 2.8).

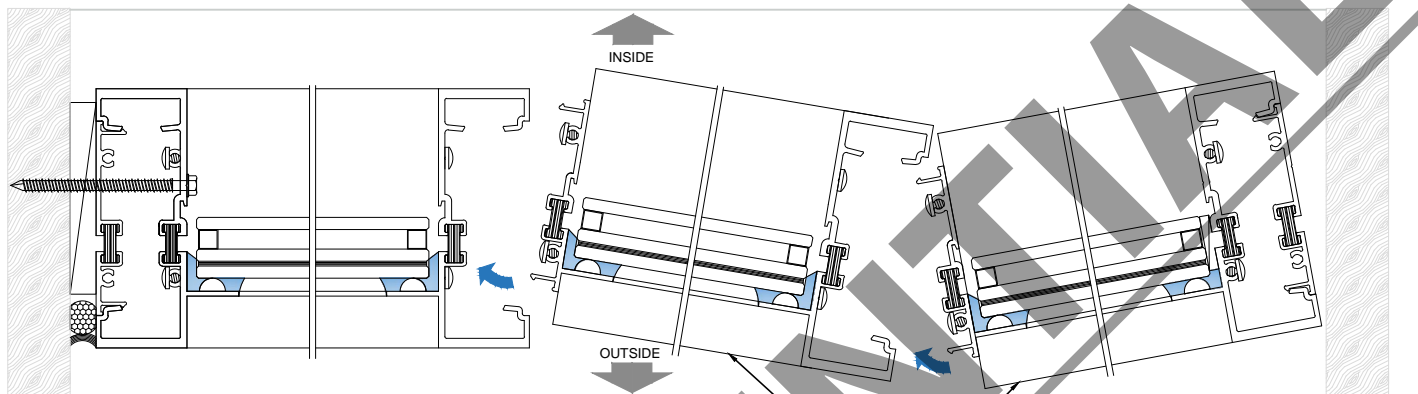

DETAIL 2.8

STEP 3

GLASS STOP INSTALLATION:

- 3.1. Prior installing the glass stops make sure that the gasket is already installed, otherwise proceed to install it.
- 3.2. Working from the inside, first install the horizontal glass stops and then the verticals glass stops. (Detail 3.2)

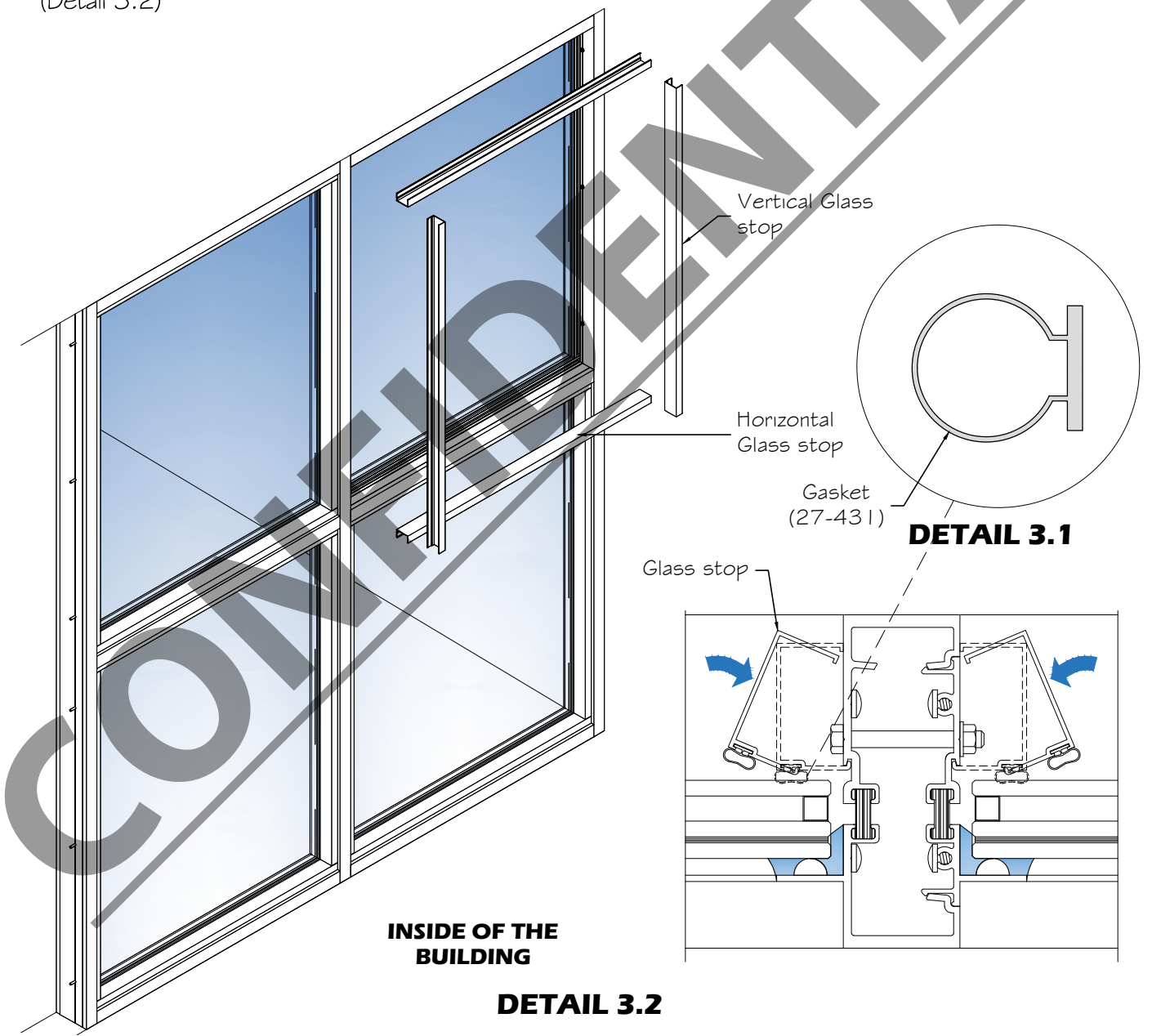

STEP 4

PERIMETER SEAL

- 4.1. Clean all surfaces to be in contact with silicone.
- 4.2. Place backer rod and apply perimeter seal per approved shop drawings. (Detail 4.2).

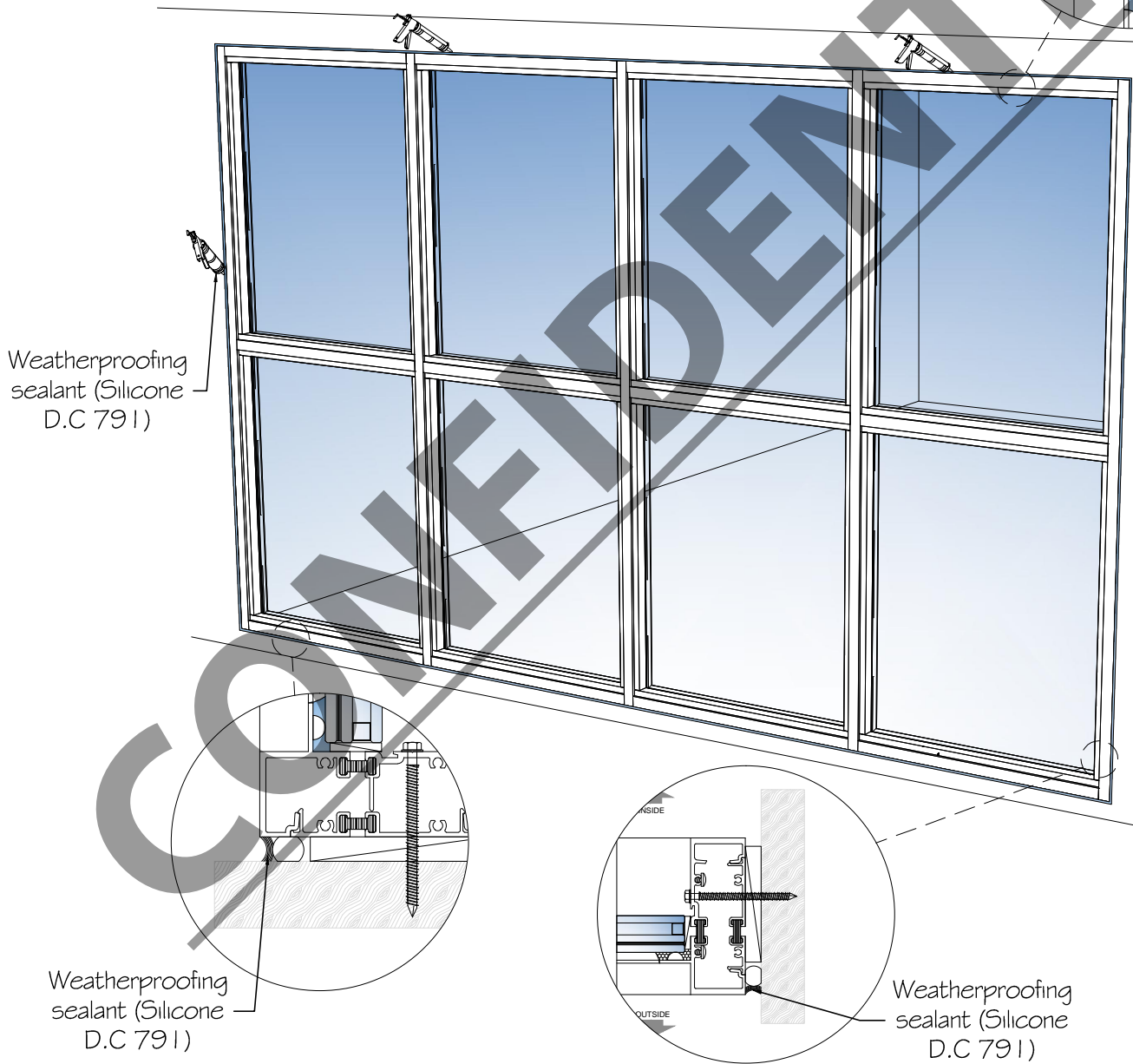

Weatherproofing sealant (Silicone D.C 791)

Weatherproofing sealant (Silicone D.C 791)

Weatherproofing sealant (Silicone D.C 791)

DETAIL 4.2

**REVIEW
No.**

DATE

DESCRIPTION

PAG.



REVIEW No.	DATE	DESCRIPTION	PAG.

CONFIDENTIAL

ESWINDOWS

**Av. Circunvalar at 100 mts of Via 40 Las Flores
Barranquilla, Colombia PBX: (57 5) 3664600
service@eswllc.com, PBX: (+1) 305 5074545**

DRAWN BY . SARIEL GONZALEZ